

# 19 LUMINA LED (24-LED)

**Construction:**

The unit consist of a body (1). A shade (3) is mounted to the luminary body with a ring (2). A disk (5) separating electrical compartment from lighting compartment, is attached to a ring (2). A LED light sources radiator (6) is settled to the disk (5). LED modules (7) are mounted to the radiator (6) with a set of lenses, by screws. The modules are powered with a power supply (8). The luminary cover (4) is mounted to the luminary body (1) with a hinge and closed with a screw (10) so no additional tools are necessary. The luminary is sealed with a gasket (9) As an option, we equip the luminary with a ZHAGA socket (11).

**Mounting instructions:**

- \*)- Mount the shade (3) to the body (1) with a ring (2). Tighten mounting bolts.
- \*)- Screw the LED light sources(7) with a lenses to the radiator (6), mount a disk (5) to the body (1).
- \*)- Connect the electrical cables according to the scheme.
- Close the cover (4), screw the bolt (10) using hand.
- Luminary is mounted to the lantern depending on the pole construction - either hanging on M20 thread or mounted on the top of the pole on  $\varnothing 45\text{-}\varnothing 90$  diameter.

If any lantern elements are supplied factory-mounted, the mounting stages marked with \*) should be omitted (as this has already been done by the manufacturer).

**Technical data:**

- Power: **~220-240V / 50-60Hz**
- Ambient/work temperature : **-30°C do +35°C**
- Protective class: **I**
- Ingress protection code: **IP66**
- Mechanical impact protection code: **IK10**
- Surge protection: **to 10kV**
- Life time: **L90, B10 >100 000h**
- Controls method: **1-10V, DALI, Ampdim, Dynadimmer,**  
as an option - **socked ZHAGA with SR driver (D4i),**

**Application:**

**Lighting: roadways, pavements, bicycle paths, markets, parks, parkings,**

**Product equipped with a replaceable light source LED - options:**

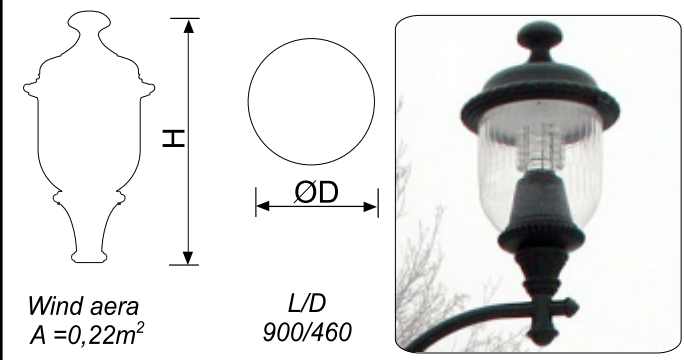
Symbol	Light source	Luminous flux [lm]			Pn [W]	If [mA]	Weight [kg]	Luminary dimensions	
		2700K (827)	3000K (830)	4000K (840)					
19 L-25W	24-LED G5	2641	2781	2940	25	300	14,5		
19 L-32W	24-LED G5	3434	3615	3822	32	400	14,5		
19 L-39W	24-LED G5	4196	4417	4670	39	500	14,5		
19 L-46W	24-LED G5	4931	5191	5488	46	600	14,5		
19 L-54W	24-LED G5	5643	5940	6281	54	700	14,5		
19 L-61W	24-LED G5	6335	6668	7051	61	800	14,5		

Luminous flux values shall be declared for ambient temperature 25°C. The class of modules used assumes 5% tolerance of the declared luminous flux value. The weight of the unit may slightly differ for individual production batches.

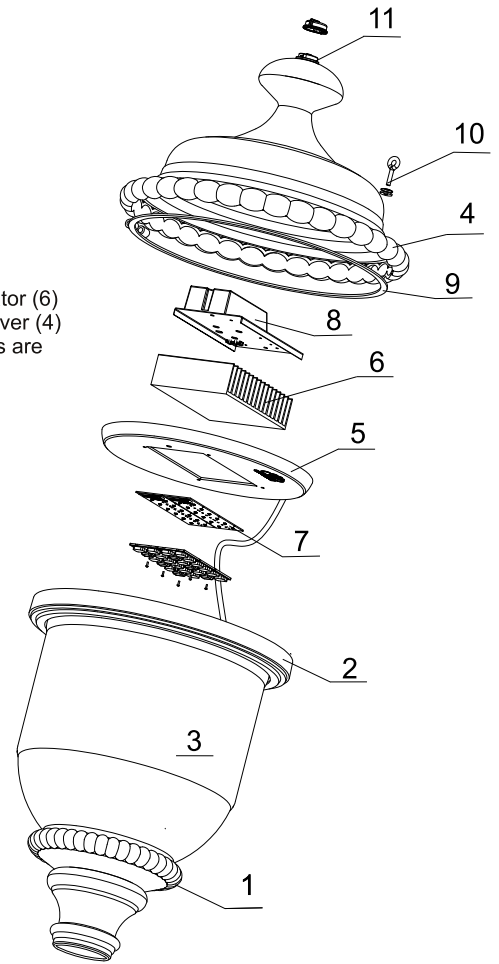

# 19 LUMINA LED (24-LED)

Available lenses - *Photometry (polar plot)* :

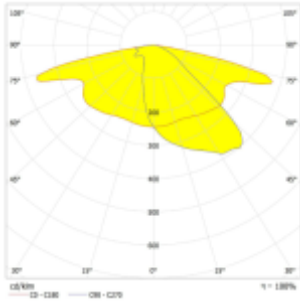

1. Basic lens ME

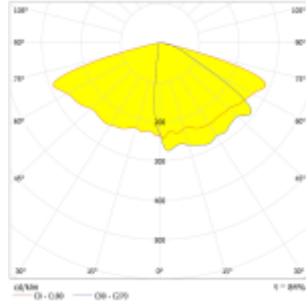

2. As an option lens T3

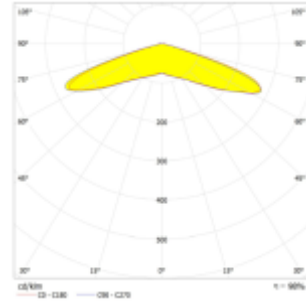

3. As an option lens VSM

Versions/assembling:

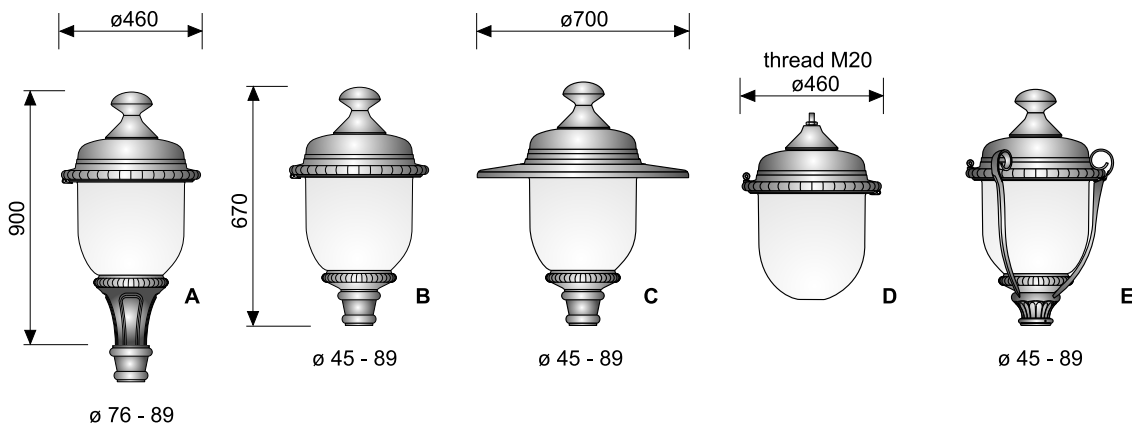

Electrical diagrams:

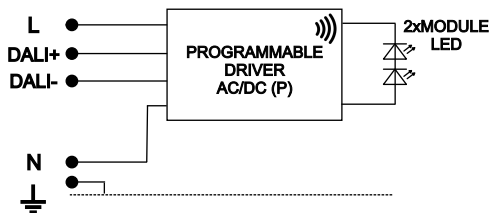

1. Light source LED  
 (basic version - programmable driver)

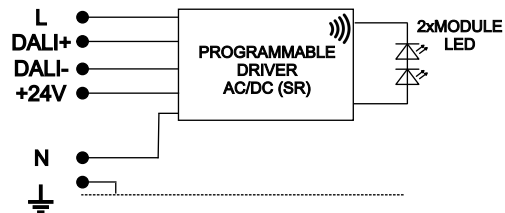

2. Light source LED  
 (version as an option - Sensor Ready driver)

-programmable driver (P) enables programming of a five-steps power reduction, surge protection to 10kV

-programmable driver (SR) enables to be powered wireless communication devices, via a ZHAGA socket, surge protection to 10kV

-detailed specifications of the power supplies include catalogue cards of their manufacturers, which we provide on request